

- Samples can deviate in the execution from the serie.

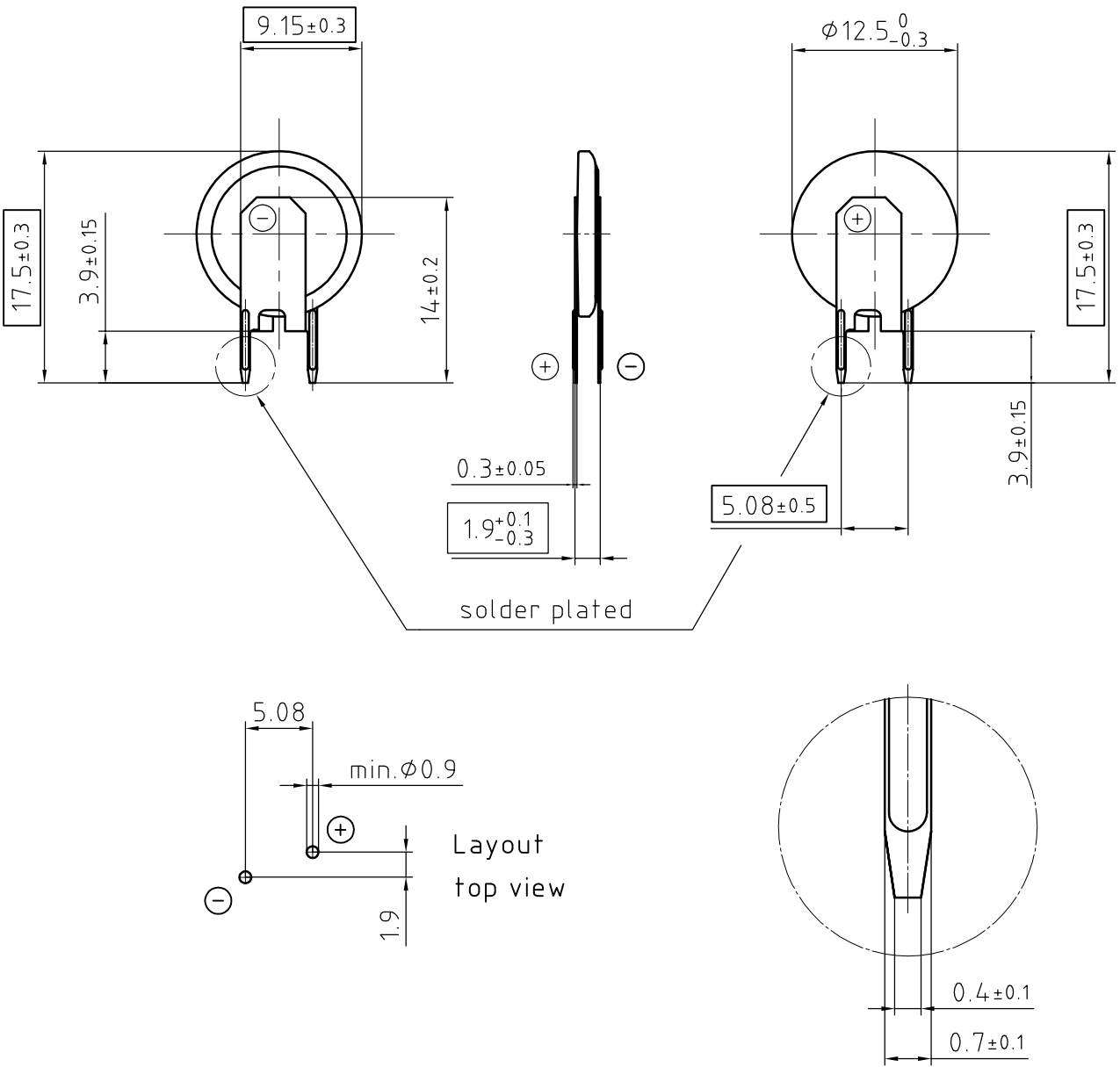

- Dimensions and tolerances can be specified only after the testing of the devices for the mass production definitely

Tab material: Stainless steel

All framed values will be used for dimension checking !

Rev.	○			Rev.	○				Customer's Approval		
Rev.	○			Rev.	○				Date		
Rev.	○			Rev.	○				Signature		
Titel:								Scale 2:1	Drawn	21.01.10	Wu Ping
CR1216 MFR FV									Checked		
									Approved		
				CH-4452 Itingen Switzerland				10.0487.4-			